

# JOLLY PLUS 2

## CROSS FLOW FAN WITH BRUSHLESS MOTOR



### TC PLUS

ON BOARD STEPLESS SPEED CONTROL. SUPPLIED AS A STANDARD ON SPECIFIC MODELS. (see following pages)

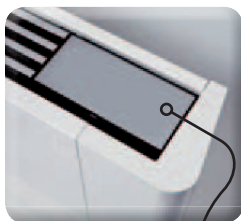

UNIT



TC-R Plus

### TC-R PLUS

STEPLESS SPEED CONTROL. TO BE ORDERED SEPARATELY. WALL INSTALLATION

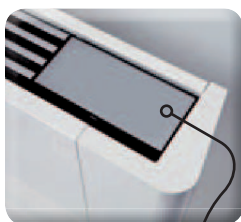

UNIT

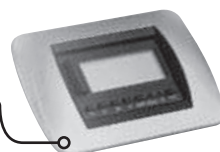

TD-3R

### TD-3R

3 SPEED CONTROL. TO BE ORDERED SEPARATELY. IN-WALL INSTALLATION

### > GENERAL FEATURES

Tangential fan coil unit series including high-efficiency brushless motors. 131 mm as maximum depth, attractively designed casing, suitable for residential heating and air conditioning applications. Available in three versions, **VM-F** featuring motorized front air inlet louvre, **VM-G** including fixed inlet grille and **VN** without casing for concealed applications. **Four sizes** and cooling capacity **from 0,83 kW to 3,34 kW**.

The careful design of the main components, refined styling and versatility make them suitable for any type of installation in the residential, commercial or industrial field.

Their installation requires only connection to the electrical and plumbing system

### > CONSTRUCTION CHARACTERISTICS

**SUPPORTING STRUCTURE:** in galvanised high-thickness sheet, integrating structural and functional elements in plastic, such as the condensate tray and fan conveyor.

**HEAT EXCHANGE COIL:** copper tube arranged in staggered rows in order to increase heat exchange. Aluminium fins, fastened by mechanical expansion of the tubes. The manifolds integrate air vents and water drain holes. The coil has a pocket for the water temperature probe. The fan coils can be ordered with left or right connection. In case of need it is however possible to rotate the coils. Conversion from left to right connection requires nevertheless an adapting kit.

**CONDENSATE TRAY:** in thermoplastic material -thus corrosion-free- supplied as a standard on models VM-G and VN. It permits either vertical and horizontal installation of the unit.

**FAN MOTOR:** the motor is a high-efficiency brushless type, speed-controlled. It is fitted on rubber supports to reduce noise transmission to the frame. Speed adjustment occurs on stepless mode. The units are also available on demand with compatibility to Ferrol 3 fixed speed control or pre existing ones.

**TANGENTIAL FAN:** the tangential-type fan is coupled directly to the motor and mounted on an anti-vibration support.

**AIR FILTER:** in polypropylene honeycomb, easily removable, it can be regenerated simply by washing with water.

**CABINET** (only VM-F and VM-G): entirely made in steel sheet and epoxy powder, coated to ensure high corrosion resistance. The air outlet grilles are on the top of the cabinet.

The side panels can be removed to ease the unit's installation and access to its internal components.

Available in colour RAL 9003.

**AIR OUTLET GRILLE** (only VM-F and VM-G): in aluminium, painted the cabinet colour. It can be rotated to get the air flow towards the room or against the wall.

### AIR INLET GRILLE

(version VM-F): in extruded aluminium. It includes two thermal actuators opening the grille in parallel with activation of the fan. A microswitch prevents fan operation when the grille is removed for periodic filter cleaning.

(version VM-G): also in extruded aluminium. It is mounted below the front panel and is fixed blades type.

Removable for filter cleaning.

**PLUMBING CONNECTIONS:** the units are equipped with EUROKONUS 3/4" plumbing connections, that allow simple and safe connection.

### > CONTROLS

Speed control can be made on progressive mode or on pre-set speeds

#### STEPLESS SPEED CONTROL

Specific controls - equipped with continuous regulation algorithms - have been developed. Such devices keep steady comfort conditions inside the room. Energy savings are also granted thanks to the fan modulation, as well as sound pressure minimization.

The electronics and its interface are available as on-board version (**TC plus**), supplied as a standard on the models on VM-F and VM-G. The unit can be however been ordered without built-in control: a remote one (**TC-R plus**) can be ordered separately as an accessory.

**TC-R plus** remote thermostat can also handle up to 31 fan-coil units connected together in parallel. This solution is suitable for medium-large rooms containing several installed units.

**Functions:** Room setpoint regulation / Automatic fan speed / Noise limiter (decreasing fan speed) / NIGHT mode (fan speed decrease / setpoint modification) / MAX (brings speed fan to max)

**Connections:** 230 V output for ON-OFF valves / Independent voltage-free contacts for activation of a chiller or boiler depending on room thermostat request / Voltage free contact for room presence (window opening contact or hotel badge).

#### PRE-FIXED SPEED CONTROL

In case a 3 speed-control is wished to be used, the interface **TD-3R** is available, for remote in-wall installation.



**The accessory needs to be ordered separately.** Jolly Plus models which are compatible with the mentioned interface can however be coupled with 3-speed thermostats which may be already present in the installation.



## INSTALLATION

	<i>Vertical above bearing feet. Room centered or against the wall</i>	<i>Vertical wall-hung</i>	<i>Vertical concealed</i>	<i>Horizontal. Ceiling mounted</i>
<b>VM-F version</b>				
<b>VM-G version</b>				
<b>VN version</b>				

## TECHNICAL DATA



MODEL		20	40	60	80
<b>PERFORMANCE</b>					
Total cooling capacity	W	830	1760	2650	3340
Sensible cooling capacity	W	620	1270	1960	2650
Water flow rate	l/h	143	303	456	574
Water pressure loss	kPa	7,2	8,4	22,5	18,6
Heating capacity at 50°C inlet water	kW	1090	2350	3190	4100
Water flow rate (50°C inlet water)	l/h	142	302	453	573
Water pressure loss (50°C inlet water)	KPa	5,7	6,6	16,3	14,0
Heating capacity without fan (50°C)	W	210	247	291	366
Heating capacity at 70°C inlet water $\Delta T$ 10	kW	1890	3990	5470	6980
Water flow rate (70°C $\Delta T$ 10)	l/h	162	343	471	600
Water pressure loss (70°C $\Delta T$ 10)	kPa	6,7	7,6	16,1	14,0
Heating capacity without fan (70°C)		322	379	447	563
<b>HYDRAULIC CHARACTERISTICS</b>					
Coil water content	litres	0,47	0,8	1,13	1,46
Max. operating pressure	bar	10	10	10	10
Plumbing connections	inches	Eurokonus 3/4	Eurokonus 3/4	Eurokonus 3/4	Eurokonus 3/4
<b>AERAULIC DATA</b>					
Max. air flow	m <sup>3</sup> /h	162	320	461	576
Air flow at medium speed (AUTO mode)	m <sup>3</sup> /h	113	252	367	453
Air flow at min. fan speed	m <sup>3</sup> /h	55	155	248	370
Available max. static pressure	Pa	10	10	13	13
<b>ELECTRICAL DATA</b>					
Power supply voltage	V/ph/Hz	230/1/50	230/1/50	230/1/50	230/1/50
Max. power absorbed	W	12	18	20	26
Max. current absorbed	A	0,11	0,16	0,18	0,26
Power absorbed at min. speed	W	4	5	5	6
<b>SOUND LEVEL</b>					
Sound pressure at max. air flow	dB(A)	39,4	40,2	42,2	42,5
Sound pressure at medium air flow	dB(A)	33,2	34,1	34,4	35
Sound pressure at min. air flow	dB(A)	24,2	25,3	25,6	26,3
<b>WEIGHT</b>					
Net weight unit VM-F / VM-G	kg	17	20	23	26
Net weight unit VN	kg	9	12	15	18

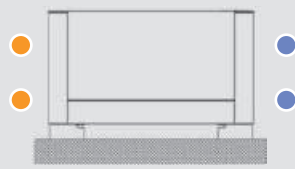

NO INSTALLED VALVES	CONTROLLER MATCHING			MODEL	20	40	60	80
	MODELS	SUPPLY						
<b>VN</b> 	<b>TC-R Plus</b> (wall installation)	<b>to be ordered separately</b>	LEFT CONNECTION	CODE	2C0270AF	2C0276AF	2C027CAF	2C027JAF
			RIGHT CONNECTION	CODE	2C0271AF	2C0277AF	2C027DAF	2C027KAF
	<b>TD-3R</b> (in-wall installation)	<b>to be ordered separately</b>	LEFT CONNECTION	CODE	2C0270LF	2C0276LF	2C027CLF	2C027JLF
			RIGHT CONNECTION	CODE	2C0271LF	2C0277LF	2C027DLF	2C027KLF
<b>VM-F</b> 	<b>TC Plus</b> (on board)	<b>already supplied</b>	LEFT CONNECTION	CODE	2C02720F	2C02780F	2C027E0F	2C027L0F
	<b>TC-R Plus</b> (wall installation)	<b>to be ordered separately</b>	LEFT CONNECTION	CODE	2C0272AF	2C0278AF	2C027EAF	2C027LAF
			RIGHT CONNECTION	CODE	2C0273AF	2C0279AF	2C027FAF	2C027MAF
	<b>TD-3R</b> (in-wall installation)	<b>to be ordered separately</b>	LEFT CONNECTION	CODE	2C0272LF	2C0278LF	2C027ELF	2C027LLF
			RIGHT CONNECTION	CODE	2C0273LF	2C0279LF	2C027FLF	2C027MLF
	<b>VM-G</b> 	<b>TC Plus</b> (on board)	<b>already supplied</b>	LEFT CONNECTION	CODE	2C027U0F	2C027W0F	2C027Y0F
<b>TC-R Plus</b> (wall installation)		<b>to be ordered separately</b>	LEFT CONNECTION	CODE	2C027UAF	2C027WAF	2C027YAF	2C027IAF
			RIGHT CONNECTION	CODE	2C027VAF	2C027XAF	2C027ZAF	2C027OAF
<b>TD-3R</b> (in-wall installation)		<b>to be ordered separately</b>	LEFT CONNECTION	CODE	2C027ULF	2C027WLF	2C027YLF	2C027ILF
			RIGHT CONNECTION	CODE	2C027VLF	2C027XLF	2C027ZLF	2C027OLF

BUILT-IN 2 WAY VALVE (VB2)	CONTROLLER MATCHING			MODEL	20	40	60	80
	MODELS	SUPPLY						
<b>VN</b> 	<b>TC-R Plus</b> (wall installation)	<b>to be ordered separately</b>	LEFT CONNECTION	CODE	2C0270BF	2C0276BF	2C027CBF	2C027JBF
			RIGHT CONNECTION	CODE	2C0271BF	2C0277BF	2C027DBF	2C027KBF
	<b>TD-3R</b> (in-wall installation)	<b>to be ordered separately</b>	LEFT CONNECTION	CODE	2C0270MF	2C0276MF	2C027CMF	2C027JMF
			RIGHT CONNECTION	CODE	2C0271MF	2C0277MF	2C027DMF	2C027KMF
<b>VM-F</b> 	<b>TC Plus</b> (on board)	<b>already supplied</b>	LEFT CONNECTION	CODE	2C02721F	2C02781F	2C027E1F	2C027L1F
	<b>TC-R Plus</b> (wall installation)	<b>to be ordered separately</b>	LEFT CONNECTION	CODE	2C0272BF	2C0278BF	2C027EBF	2C027LBF
			RIGHT CONNECTION	CODE	2C0273BF	2C0279BF	2C027FBF	2C027MBF
	<b>TD-3R</b> (in-wall installation)	<b>to be ordered separately</b>	LEFT CONNECTION	CODE	2C0272MF	2C0278MF	2C027EMF	2C027LMF
			RIGHT CONNECTION	CODE	2C0273MF	2C0279MF	2C027FMF	2C027MMF
	<b>VM-G</b> 	<b>TC Plus</b> (on board)	<b>already supplied</b>	LEFT CONNECTION	CODE	2C027U1F	2C027W1F	2C027Y1F
<b>TC-R Plus</b> (wall installation)		<b>to be ordered separately</b>	LEFT CONNECTION	CODE	2C027UBF	2C027WBF	2C027YBF	2C027IBF
			RIGHT CONNECTION	CODE	2C027VBF	2C027XBF	2C027ZBF	2C027OBF
<b>TD-3R</b> (in-wall installation)		<b>to be ordered separately</b>	LEFT CONNECTION	CODE	2C027UMF	2C027WMF	2C027YMF	2C027IMF
			RIGHT CONNECTION	CODE	2C027VMF	2C027XMF	2C027ZMF	2C027OMF

BUILT-IN 3 WAY VALVE (VB3)	CONTROLLER MATCHING			MODEL	20	40	60	80
	MODELS	SUPPLY						
<b>VN</b> 	<b>TC-R Plus</b> (wall installation)	<b>to be ordered separately</b>	LEFT CONNECTION	CODE	2C0270CF	2C0276CF	2C027CCF	2C027JCF
			RIGHT CONNECTION	CODE	2C0271CF	2C0277CF	2C027DCF	2C027KCF
	<b>TD-3R</b> (in-wall installation)	<b>to be ordered separately</b>	LEFT CONNECTION	CODE	2C0270NF	2C0276NF	2C027CNF	2C027JNF
			RIGHT CONNECTION	CODE	2C0271NF	2C0277NF	2C027DNF	2C027KNF
<b>VM-F</b> 	<b>TC Plus</b> (on board)	<b>already supplied</b>	LEFT CONNECTION	CODE	2C02722F	2C02782F	2C027E2F	2C027L2F
	<b>TC-R Plus</b> (wall installation)	<b>to be ordered separately</b>	RIGHT CONNECTION	CODE	2C02732F	2C02792F	2C027F2F	2C027M2F
			LEFT CONNECTION	CODE	2C0272CF	2C0278CF	2C027ECF	2C027LCF
	<b>TD-3R</b> (in-wall installation)	<b>to be ordered separately</b>	RIGHT CONNECTION	CODE	2C0273CF	2C0279CF	2C027FCF	2C027MCF
			LEFT CONNECTION	CODE	2C0272NF	2C0278NF	2C027ENF	2C027LNF
	<b>TD-3R</b> (in-wall installation)	<b>to be ordered separately</b>	RIGHT CONNECTION	CODE	2C0273NF	2C0279NF	2C027FNF	2C027MNF

## ACCESSORIES

REMOTE CONTROL							
MODEL		DESCRIPTION	20	40	60	80	CODE
TC-R PLUS		Remote user interface - continuous control thermostat	•	•	•	•	2C0275YF
TD-3R		Remote digital user interface - 3 speed control	•	•	•	•	2C0211YF

HYDRAULIC ACCESSORIES							
MODEL		DESCRIPTION	20	40	60	80	CODE
VB 2		2-way valve	•	•	•	•	2C0212YF
VB 3		3-way valve	•	•	•	•	2C0213YF
KRE 3/4"	-	Conversion kit Eurokonus 3/4" F	•	•	•	•	2C0219YF
KRE 1/2"	-	Conversion kit Eurokonus 1/2" F	•	•	•	•	2C021AYF
KLR PLUS	-	Water connection conversion left to right	•	•	•	•	2C0238YF

## ACCESSORIES

### INSTALLATION ACCESSORIES

#### VM-F / VM-G version

MODEL		DESCRIPTION	20	40	60	80	CODE
PC 20		Front closing panel mod VM-F / VM-G 20	•				2C0270XF
PC 40		Front closing panel mod VM-F / VM-G 40		•			2C0271XF
PC 60		Front closing panel mod VM-F / VM-G 60			•		2C0272XF
PC 80		Front closing panel mod VM-F / VM-G 80				•	2C0273XF
PE		Cover feet (for wall-hung installation)	•	•	•	•	2C0278XF
PA		Bearing feet	•	•	•	•	2C0279XF

#### VN version

MODEL		DESCRIPTION	20	40	60	80	CODE
CF 20		Formwork mod VN 20	•				2C021LWF
CF 40		Formwork mod VN 40		•			2C021MWF
CF 60		Formwork mod VN 60			•		2C021NWF
CF 80		Formwork mod VN 80				•	2C021PWF
PCF 20		Cover panel mod VN 20	•				2C021QWF
PCF 40		Cover panel mod VN 40		•			2C021RWF
PCF 60		Cover panel mod VN 60			•		2C021SWF
PCF 80		Cover panel mod VN 80				•	2C021TWF
RA 20		Air intake fitting mod VN 20	•				2C0210WF
RA 40		Air intake fitting mod VN 40		•			2C0211WF
RA 60		Air intake fitting mod VN 60			•		2C0212WF
RA 80		Air intake fitting mod VN 80				•	2C0213WF
PMT 20		Flow telescopic plenum mod VN 20	•				2C0214WF
PMT 40		Flow telescopic plenum mod VN 40		•			2C0215WF
PMT 60		Flow telescopic plenum mod VN 60			•		2C0216WF
PMT 80		Flow telescopic plenum mod VN 80				•	2C0217WF
PMP 20		Flow perpendicular plenum mod VN 20	•				2C0218WF
PMP 40		Flow perpendicular plenum mod VN 40		•			2C0219WF
PMP 60		Flow perpendicular plenum mod VN 60			•		2C021AWF
PMP 80		Flow perpendicular plenum mod VN 80				•	2C021BWF
GM 20		Flow grille-curved blades mod VN 20	•				2C021CWF
GM 40		Flow grille-curved blades mod VN 40		•			2C021DWF
GM 60		Flow grille-curved blades mod VN 60			•		2C021EWF
GM 80		Flow grille-curved blades mod VN 80				•	2C021FWF
GA 20		Intake grille-curved blades mod VN 20	•				2C021GWF
GA 40		Intake grille-curved blades mod VN 40		•			2C021HWF
GA 60		Intake grille-curved blades mod VN 60			•		2C021JWF
GA 80		Intake grille-curved blades mod VN 80				•	2C021KWF

## DIMENSIONS

### VM-F e VM-G version

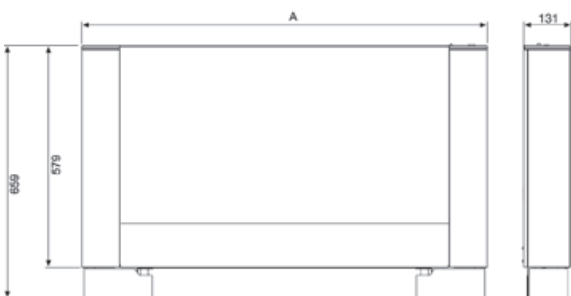

### VN version

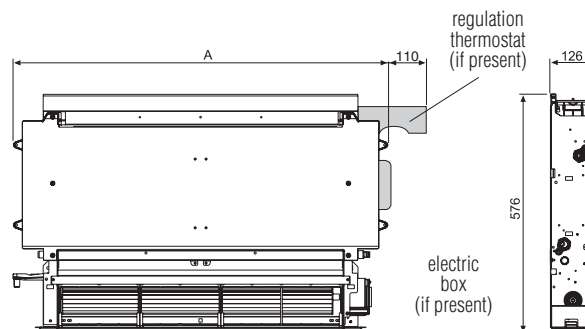

MODEL	20	40	60	80
VM-F / VM-G (mm)	735	935	1135	1335
VN (mm)	479	679	879	1079